

2017-2018년 신판



경보스텐산업
KYUNG-BO STAINLESS IND.



경보레이저 기술 금속
KYUNG-BO LASER TECHNO METAL.

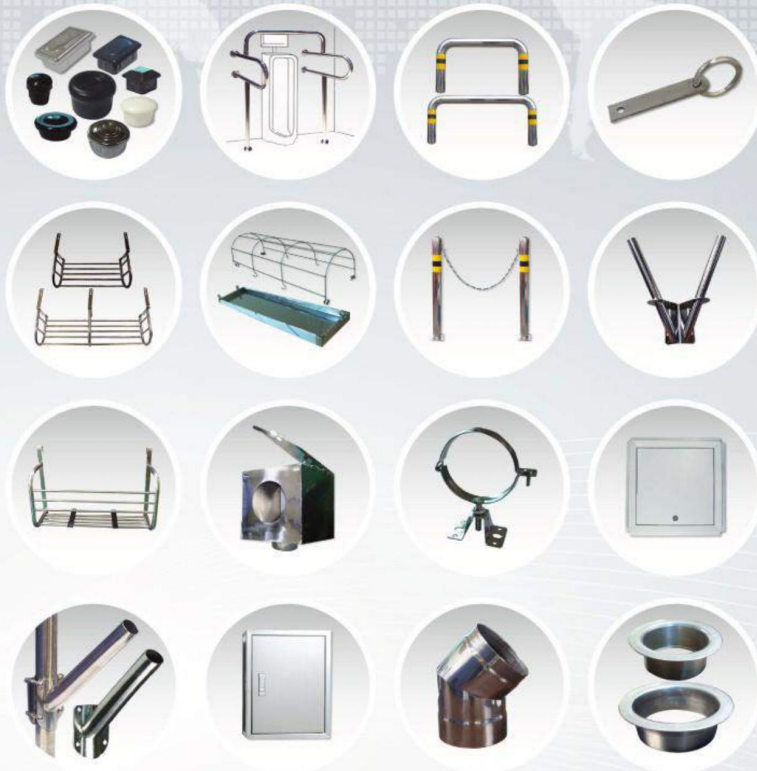

다양한 건축스텐 부속과 강화도어 및 각종 손잡이
| 각종 부속 주문제작 시판 및 직수입 유통



소재·부품 전문기업



중부화재상해보험
생산물배상책임보험



장애인기업등록
제0013-2012-0019호



ISO 9001 : 2008



정부조달업체 등록기업



벤처기업등록 제20140112954호



경보스텐산업
KYUNG-BO STAINLESS IND.



경보레이저 기술 금속
KYUNG-BO LASER TECHNO METAL.



경보스텐산업과 경보레이저기술금속 (쇼필몰 - 스텐세일 www.kbsteel.com / www.steelkb.co.kr) 은 건축 스텐 부속 전문제조 및 직수입 납품업체로서 고객의 다양한 요구에 맞추기 위해 최선의 노력을 다하고 있습니다.

최신 레이저 기계(2D·3D)도입으로 현재 상호 잡철물 단종업체와 건설시공사에 다양한 제품을 납품하며 다수의 금형제작과 직수입 유통으로 국내외 건설 및 토목 건축 시공업체에 이바지하고 있습니다.

본사는 장애인등록기업 및 벤처기업등록업체로 본사 수익금중 일부를 장애우 단체 및 기타 사회봉사단체에 기부하고 있습니다.

각종 연마와 용접가공 및 금형제작 주문 받습니다















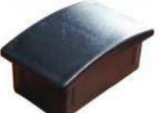
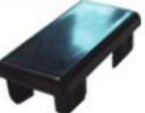



CONTENTS

PVC마개(사각 / 원형)	1
사각 PVC마개(파이프 마개) / 아시바용 안전마개 / 사각덮개 마구리	2
실리콘 캡 / 플라스틱 캡	3
스텐 대문손잡이(25.4Ø)A·B·C형 / 지하철손잡이 / 스텐 파이프 대문손잡이	4
PVC마개(내부너트 / 비너트) / 조경발 / 조종와샤 / 캐비닛발(용접용) / 칼라우편함	5
아파트베란다 화분대 / 화분대 물받이 / 화분대 미니하우스 / 에어컨 실외기 받침대	6
태극기(가정용 태극기 / 가로등용 태극기)	7
국기꽃이(일반 벽체용 / 가로등용) / 베이스판(스텐)	8
스텐 파이프 핸들 / 마주핸들 / 원형핸들	8
스텐 캡(하캡, 신주) 스텐45° (경사)캡 / 스텐 캡(확관 파이프용)	9
스텐 캡(원각캡) / 스텐가락지 / 스텐 사각캡(사각×사각)	10
스텐 사각캡(사각×사각)	11
스텐 원형 마구리 / 스텐 사각 마구리(T1.0) / 스텐 덮개 마구리	12
파이프 각도기(45°, 90°) / 상캡(용접용)45°, 90° / 비용접(발)45°, 90°	13
25Ø 비용접-(45°, 90°)고무 / 25Ø 각파이프용(45°, 90°)	
신주공 / 스텐공 / 반볼 / 공 + 쏘인트 부착(볼탈)일체형 / 볼탑(반달공)	14
관통볼(한쪽,양쪽) / 스텐 장식볼 / 자바라 볼탑 / 볼 쏘인트 / 스텐 소켓트	15
25Ø 원형 소켓트 / 25Ø U 소켓트 / 놀이터 캡	
스텐 단구, 양구 / 스텐후렌지(S/T, 304×1.5T) / 신주 후렌지(황동 1.5T)	16
가로등캡 / 파이프 홀더 / 안전봉 고리	
스텐 와샤(T1.0) / 스텐 평와샤(R형) (T3.0)	17
스텐 평 와샤(T3.0, T2.0) / 포스트바(캡, 밀판) / 태극기	
스텐 국기봉 / 신주(황동)국기봉 / 국기대 / 국기꽃이 (신형, 벽부) / 로프걸이	18
이중로프걸이 / 국기로라 / 곡와샤 / 국기대 롱볼트(16Ø)레듀샤	
물흡통 / 물흡통 반도(양가용, 판넬용) / 물흡통 파이프 연결링	19
물흡통 연결링(동) / 물흡통반도(동) / 물흡통망 / 물받이 구찌 / 청소용 고리	20
스텐 점검구 / 철 점검구(갈바) / 천정용 점검구(동전키, 엇는 타입)	21
장애자용 화장실 보조손잡이	22
장애자용 보조 손잡이 / 우편함 / 스텐차단대(50.8Ø) / 신주차단대(50.8Ø)	23
지차대(매립형) / 지차대(U자매립형 볼라드) / 지차대(이동식)	24
스텐 마르보빗장 / 스텐 파이프 통빗장 / 스텐 파이프 빗장 / 스텐 오도시	25
스텐 돌쩌귀 / 16Ø, 19Ø 샷다링 / 이중 링구(W링)대문힌지 / 스텐샷다 마개	26
각엘보(조립식엘보, 확관엘보) T1.1	27
+ 형 확관 조립식 엘보 / 3·4·5방향 확관 조립식 엘보	28
스텐엘보(45°, 90°) / 한쪽엘보 / 양쪽엘보	29
물흡통 관통T형 엘보 / T형 확관 조립식 엘보 / 벽체 / 한쪽 롱엘보 / 풀용접 확관 조립엘보	30
쫓대함 2단 / 3단	31
자전거 거치대 / 레이저 조각 / 칼라콘 / 원형 오투기 표지판	32
강화도어 특수(제작)손잡이	33
강화도어 나무손잡이 / 강화도어 스텐(제작)손잡이	
사각, 팔각 아크릴 / 원형 아크릴 / 투명 아크릴핸들	
흡부속 / 보조키 / 스트라이크 / 유리 구멍마개 / 유리걸이	36
가네모 힌지 후렘부속	37



※ PVC마개 종류 국내 최다 금형 보유 (금형 제작 문의 받습니다.) ※

사각 PVC마개 (파이프 마개)

619  50mm X 50mm	620  40mm X 40mm	621-1  30mm X 30mm	621-2  30mm X 30mm	622  30mm X 50mm	622-1  30mm X 60mm	
623  20mm X 40mm	623-1  20mm X 40mm	623-2  20mm X 40mm	627-1  25mm X 25mm	627-2  25mm X 25mm	627-3  20mm X 20mm <small>파이프 두께 1.5T 이상</small>	627-4  19mm X 19mm <small>파이프 두께 1.5T 이상</small>
627-5  25mm X 25mm	1201  45mm X 75mm	1202  75mm X 75mm	1203  20mm X 30mm	1204  20mm X 30mm	1223  60mm X 60mm (회색) <small>(흑색)대량주문시 가능</small>	

원형 PVC마개 (파이프 마개)

624  38Ø(속/흑색)	624-5  38Ø(속/크롬)	624-6  38Ø(겉/고무)	624-7  38Ø(속/신흑색)	625-1  32Ø(겉/흑색)	625-2  32Ø(겉/백색)	
625-3  32Ø(속/흑색)	625-4  32Ø(속/백색)	625-5  32Ø(속/크롬)	625-6  32Ø(속/신흑색)	626-1  25Ø(겉/흑색)	626-2  25Ø(겉/백색)	626-3  25Ø(속/흑색)
626-4  25Ø(속/백색)	1209  22Ø(겉/흑색)	1210  22Ø(겉/백색)	1211  22Ø(속/흑색)	1212  22Ø(속/백색)	1213  19Ø(겉/흑색)	1214  19Ø(겉/백색)
1215  19Ø(속/흑색)	1216  16Ø(겉/백색)	1217  16Ø(속/흑색)	1218  50Ø(속/크롬)	1219  50Ø(속/흑색)	1220  63Ø(속/크롬)	1221  63Ø(속/흑색)



※ PVC마개 종류 국내 최다 금형 보유 (금형 제작 문의 받습니다.) ※

사각 PVC마개 (파이프 마개)

619-1 50mm X 50mm	620-2 40mm X 40mm	621-3 30mm X 30mm	622-2 30mm X 50mm	622-3 30mm X 60mm	623-3 20mm X 40mm
625-8 32Ø (속/신회색)	627-6 25mm X 25mm	627-7 20mm X 20mm	1201-1 45mm X 75mm	1202-1 75mm X 75mm	
1204-1 20mm X 30mm	1224 50mm X 100mm	1224-1 50mm X 100mm	1225 100mm X 100mm	1225-1 100mm X 100mm	

기존에 카탈로그에 있는 PVC마개들은 수량이 많을 경우 색상 변경주문이 가능하며 크롬도금도 가능하오니 문의 바랍니다. (아시바 마개 제외)
- 단 주문시 충분한 시간을 주셔야 합니다. -

아시바용 안전마개

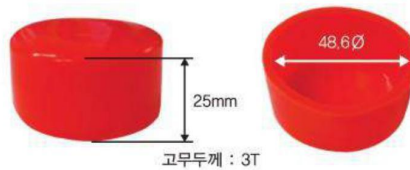

재 질 : 고무
두께 : 3T
사이즈 : 48.6Ø용 걸마개

사각덮개 마구리

590-2 50mm X 50mm	590-3 40mm X 40mm	591-2 75mm X 75mm	592-2 80mm X 80mm	593-2 100mm X 100mm	593-3 50mm X 100mm
--------------------------	--------------------------	--------------------------	--------------------------	----------------------------	---------------------------



실리콘 캡



형광파이프캡 42, 48

재 질 : 실리콘
규 격 : 48mm, 42mm
포장단위 : 한봉 100개

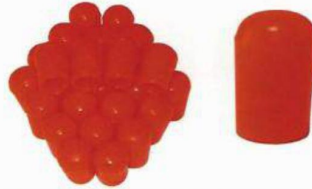

형광파이프캡 7~8

사용범위 : 7mm ~ 8mm
포장단위 : 한봉 1000개



형광철근캡 10~48

사용범위 : 10mm ~ 13mm
포장단위 : 한봉 500개



형광철근캡 16~19

사용범위 : 16mm ~ 19mm
포장단위 : 한봉 500개

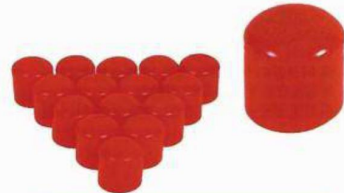

형광철근캡 21~25

사용범위 : 21mm ~ 25mm 겸용
포장단위 : 한봉 500개
특 징 : 철근캡 안쪽 돌출부위가 철근 크기에 따라 사용가능케 함



형광철근캡 30~32

사용범위 : 30mm ~ 32mm
포장단위 : 한봉 100개



형광철근캡 35~38

사용범위 : 35mm ~ 38mm 겸용
포장단위 : 한봉 100개

플라스틱 캡



파이프캡 - 구형

내 경 : 34mm ~ 36mm
외 경 : 50mm



파이프캡 - 신형

내 경 : 22mm ~ 32mm
외 경 : 50mm



슈퍼철근캡

사용범위 : 10mm ~ 27mm



철근캡 - 구형

내 경 : 10mm ~ 16mm



철근캡 - 신형

내 경 : 10mm ~ 19mm



클램프 캡



스텐 대문 손잡이 - 25.4Ø

(A형)



스텐 대문 손잡이 - 25.4Ø

(B형)



스텐 대문 손잡이 - 25.4Ø, 22.1Ø

(C형)



지하철 손잡이(로구로) - 25.4Ø



지하철 손잡이 - 25.4Ø

※ 주문제작 가능 ※



스텐 대문 손잡이 - 25.4Ø

※ 주문제작 가능 ※





경보스텐산업
KYUNG-BO STAINLESS IND.

Shopping mall 스텐세일
www.stainsale.com

※ PVC마개 종류 국내 최대 금형 보유 (금형 제작 문의 받습니다.) ※

PVC마개 (내부너트 / 비너트)

스텐 조종 와샤

1205



(내부너트)
75mm X 75mm
(속 / 흑색)

1206

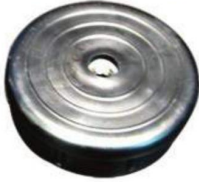

(내부너트)
101Ø
(속 / 흑색)

1207



(내부너트)
38Ø
(속 / 흑색)

1208



(로라형 / 비너트)
38Ø
(속 / 흑색)

1309



※ 본사 특허등록 제품 ※
앞 뒤
(볼트구멍 : 15.8mm)

조종발 / 조정발

※ 본사 특허등록 제품 ※

1301



38Ø

1302



40mm X 40mm

1303



38Ø(롱)

1304



40mm X 40mm(롱)

1305



38Ø(크롬)

1306



40mm X 40mm(크롬)

캐비닛발(용접용)



칼라 우편함





아파트 베란다 화분대(베란다 화분걸이대)

※ 본사 특허등록 제품 ※

973
550mm

재 질 : 스테인레스304(27종)
색 상 : 스테인레스
사이즈 : 길이(L) × 폭(W) × 높이(H)
550mm × 280mm × 200mm

974
1000mm

재 질 : 스테인레스304(27종)
색 상 : 스테인레스
사이즈 : 길이(L) × 폭(W) × 높이(H)
1000mm × 280mm × 200mm

975
1200mm

재 질 : 스테인레스304(27종)
색 상 : 스테인레스
사이즈 : 길이(L) × 폭(W) × 높이(H)
1200mm × 280mm × 200mm

976
1500mm

재 질 : 스테인레스304(27종)
색 상 : 스테인레스
사이즈 : 길이(L) × 폭(W) × 높이(H)
1500mm × 280mm × 200mm

화분대 스텐 물받이

※ 본사 특허등록 제품 ※

상품명 : 물받이
재 질 : 스테인레스430(24종)
색 상 : 스테인레스
사이즈 : 길이(L) : 550mm, 1000mm, 1200mm, 1500mm (호수포함)

화분대 스텐 미니하우스

※ 본사 특허등록 제품 ※

상품명 : 미니하우스 설치대
재 질 : 스테인레스304(27종)
색 상 : 스테인레스
사이즈 : 길이(L) : 550mm, 1000mm, 1200mm, 1500mm

- 973-2**
550mm
- 974-2**
1000mm
- 975-2**
1200mm
- 976-2**
1500mm

- 973-3**
550mm
- 974-3**
1000mm
- 975-3**
1200mm
- 976-3**
1500mm

에어컨 실외기 받침대 (발코니용)

※ 본사 특허등록 제품 ※

1404 발코니용 中

750mm
외측 400mm
500mm
내측 850mm

1406 발코니용 大

870mm
외측 480mm
600mm
내측 1000mm

에어컨 실외기 받침대 (벽체용)

※ 본사 특허등록 제품 ※

1405 벽체용 中

750mm
외측 400mm
500mm
내측 850mm

1407 벽체용 大

870mm
외측 480mm
600mm
내측 1000mm



경보스텐산업
KYUNG-BO STAINLESS IND.

Shopping mall

스텐세일
www.stainsale.com

태극기 (가정용 태극기 / 가로등용 태극기)

※ 본사 특허등록 제품 ※

850-1

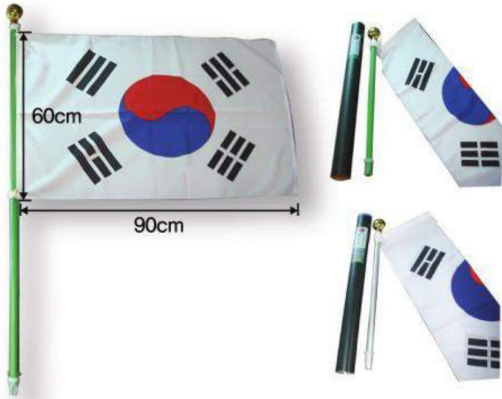

가정용 태극기

바람에 영키지않는 태극기(케이스 포함)
깃대 종류 - 알루미늄 / 플라스틱

850-2



가로등용 태극기

SIZE : 800mm × 1300mm

국기꽃이 (일반 벽체용 / 가로등용)

※ 본사 특허등록 제품 ※

853-1

※ 본사 특허등록 제품 ※



가정용 벽부

853-2

※ 본사 특허등록 제품 ※



파이프 내경(속) : 23.5mm

853-7

※ 본사 특허등록 제품 ※



853-10

※ 본사 특허등록 제품 ※



가로등용

파이프 내경(속) : 20mm

853-11

※ 본사 특허등록 제품 ※



가로등용

파이프 내경(속) : 20mm

베이스판 (스텐)

사이즈, 두께 주문제작 가능합니다

1451



SIZE : 120mm × 120mm × 5T

1452



SIZE : 150mm × 150mm × 5T

1453



SIZE : 200mm × 200mm × 6T



파이프 핸들 (파이프 손잡이)



NO	SIZE	
	Ø	규격
179	31.8	250mm × 550mm(신주)
180	25.4	200mm × 550mm(신주)
181	25.4	양볼트
182	25.4	양꼭지
183	31.8	250mm × 550mm
184	25.4	250mm × 550mm
185	25.4	200mm × 200mm
186	25.4	200mm × 350mm
187	25.4	200mm × 450mm
188	25.4	200mm × 550mm
189	25.4	200mm × 650mm

※ 파이프 핸들 규격은 200mmX200mm부터 200mmX1,000mm까지 50mm간격으로 제품이 준비되어 있습니다.
 ※ 단, 규격 센타 이외(강화유리 작업상) 오차 발생한 센타도 제작 가능합니다.

파이프 핸들 (마주 손잡이)

※ 주문제작 가능 ※

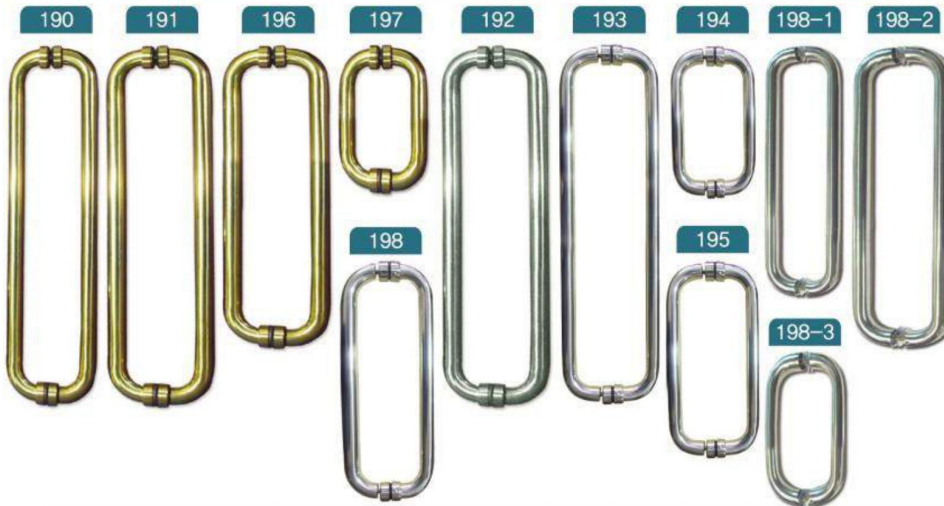

NO	SIZE	
	Ø	규격
190	25.4	550mm(신주)
191	31.8	550mm(신주)
192	31.8	550mm
193	25.4	550mm
194	25.4	200mm
195	25.4	340mm
196	31.8	400mm(신주)
197	25.4	200mm(신주)
198	31.8	400mm
198-1	25.4	340mm(피스식)
198-2	25.4	500mm(피스식)
198-3	25.4	200mm(피스식)

※ 마주핸들 규격은 200mm부터 50mm 간격으로 제작 가능합니다. (스텐마주는 턱있는 제품과 턱없는제품 선택가능합니다.)

원형핸들 (원형 손잡이)





스텐캡 (하캡)

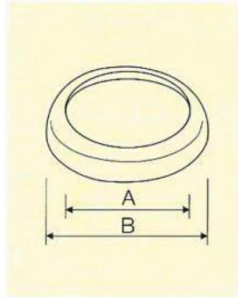

NO.	Size		NO.	Size	
	내경(A)	외경(B)		내경(A)	외경(B)
449	15.8	51	456	63.5	90
450	19.1	51	457	76.3	104
451	22.3	51	458	89.1	125
452	25.4	52	459	101.6	140
453	31.8	54	460	127	173
454	38.1	56	461	152.4	200
455	50.8	75	461-1	165.2	217

단위 (m/m)

캡 (신주)

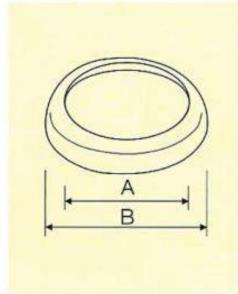

NO.	Size		NO.	Size	
	내경(A)	외경(B)		내경(A)	외경(B)
462	15.8	51	469	63.5	90
463	19.1	51	470	76.3	104
464	22.3	54	471	89.1	125
465	25.4	54	472	101.6	140
466	31.8	61	473	127	168
467	38.1	61	474	152.4	225
468	50.8	78			

단위 (m/m)

스텐 45° (경사캡)

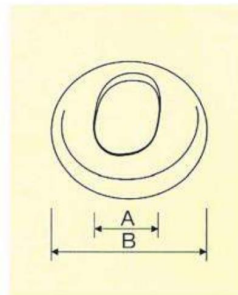

NO.	Size		NO.	Size	
	내경(A)	외경(B)		내경(A)	외경(B)
475	25.4	54	481	101.6	173
476	31.8	61			
477	38.1	79			
478	50.8	96			
479	63.5	127			
480	76.3	141			

단위 (m/m)

스텐캡 (확관파이프용)



NO.	Size	
	내경(A)	외경(B)
482	35	61
483	43.5	61
484	56	79

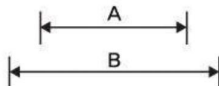

스텐(小)캡



NO.	Size	
	내경(A)	외경(B)
485	19.1	29
486	19.1	40
487	22.3	40
488	25.4	40
489	50.8	65

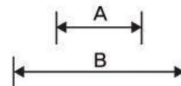

단위 (m/m)



스텐캡 (원각캡)

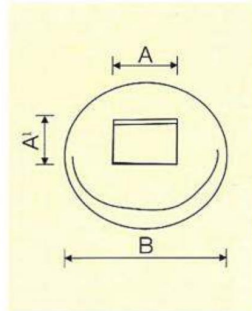
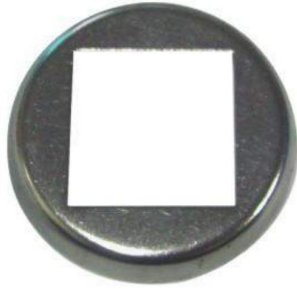

단위 (m/m)

NO.	Size	
	내경(A×A1)	외경Ø (B)
490	16×16	51
491	21×21	51
492	26×26	60
493	32×32	60
494	41×41	78
495	51×51	95
496	6×52	78
496-1	7×39	60
497	6×31	60
497-1	8×52(小)	60

NO.	Size	
	내경(A×A1)	외경Ø (B)
498	8×52	78
499	10×51	78
500	10×76	104
501	11×33	60
502	11×40	60
503	13×41	60
504	20×30	60
505	21×41	60

NO.	Size	
	내경(A×A1)	외경Ø (B)
506	21×61	95
507	31×41	78
508	31×51	78
509	31×71	104
510	42×62	104
511	46×76	117
512	13×51	78
513	10×26	51

가락지

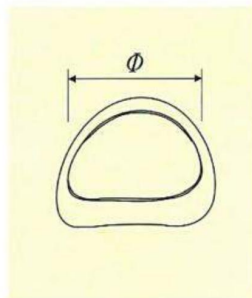

단위 (m/m)

NO.	Size	비고
	Ø(내경)	
514	15.8	
515	19.1	
516	25.4	
517	31.8	
518	38.1	

스텐 사각캡

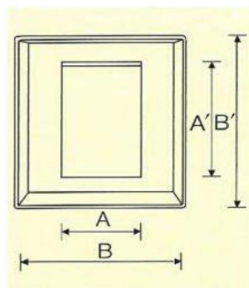

단위 (m/m)

NO.	Size			NO.	Size		
	내경(A×A')	외경(B×B')	높이		내경(A×A')	외경(B×B')	높이
519	11×11	30×30	8	525	52×52	76×76	13
520	16×16	40×40	8	526	61×61	88×88	15
521	21×21	40×40	8	527	72×72	116×116	15
522	26×26	50×50	10	528	76×76	116×116	15
523	32×32	50×50	9	529	82×82	116×116	15
524	41×41	76×76	15	530	102×102	155×155	20



스텐 사각캡

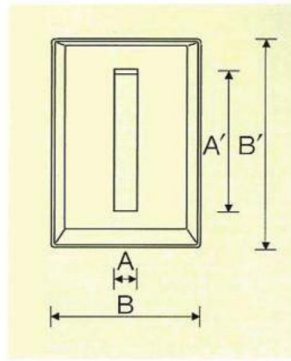

단위 (m/m)

NO.	Size		
	내경(A×A')	외경(B×B')	높이
531	3×30	30×50	8
532	5×50	30×70	12
533	6×53	30×70	12
534	6×60	53×108	13
535	7×31	40×60	12
536	7×39	30×70	12

단위 (m/m)

NO.	Size		
	내경(A×A')	외경(B×B')	높이
537	7×66	40×104	12
538	8×52	30×70	12
539	10×51	30×70	12
540	10×61	40×104	12
540-1	10×66	40×104	12
541	10×76	40×104	8
542	11×21	30×50	8
543	11×33	30×70	12
544	11×41	30×70	12
545	13×39	30×70	12
546	13×51	30×70	12
547	13×66	40×104	12
548	13×76	53×108	13
549	16×26	40×60	12
550	16×36	40×60	12
551	20×30	40×60	12
552	21×41	40×60	12
553	21×61	53×108	13

단위 (m/m)

NO.	Size		
	내경(A×A')	외경(B×B')	높이
554	25×80	53×108	13
555	31×41	50×70	10
556	31×51	50×70	12
557	31×71	65×104	13
558	35×75	65×104	13
559	42×62	78×117	13
560	41×76	78×117	13
561	42×81	78×117	13
562	41×101	96×146	16
563	41×121	71×151	16
564	46×76	78×117	13
565	51×72	78×117	12
566	51×91	78×117	14
567	51×101	96×146	16
568	61×91	96×146	16
569	61×101	96×146	16
570	10×26	30×50	8
571	11×110	96×146	16



스텐 원형 마구리

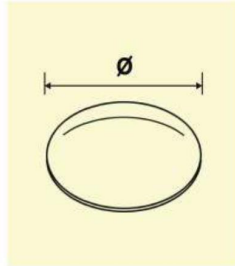

NO.	Size	NO.	Size
	ø		ø
572	19.1	559	76.3
573	22.3	580	89.1
574	25.4	581	101.6
575	31.8	582	127.0
576	38.1	583	152.4
577	50.8	584	165
578	63.5	585	216

단위 (m/m)

스텐 사각 마구리 (T1.0)

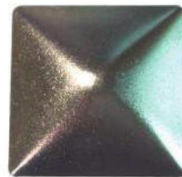
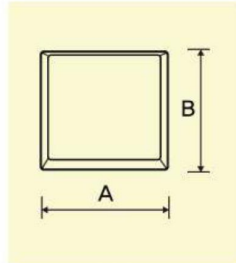

NO.	Size	NO.	Size
	외경(A×B)		외경(A×B)
586	20×20	593	100×100
587	25×25	594	20×40
588	30×30	595	30×50
589	40×40	596	30×70
590	50×50	597	40×60
590-1	60×60	598	40×80
591	70×70	599	50×70
591-1	75×75	600	50×100
592	80×80		

단위 (m/m)

스텐 덮개 마구리



NO.	Size
	외경(A×B)
601	19.1
602	25.4
603	31.8
604	38.1
605	50.8
606	63.5
607	76.3
608	101.6
609	127.0
610	152.4

단위 (m/m)

스텐 조립 마구리



NO.	Size
	외경(A×B)
601-1	19.1
602-1	25.4
603-1	31.8
604-1	38.1
605-1	50.8
606-1	63.5
607-1	76.3
608-1	101.6
609-1	127.0
610-1	152.4

단위 (m/m)

스텐층 마구리



NO.	Size
	외경(A×B)
611	19.1
612	25.4
613	31.8
614	38.1
615	50.8
616	63.5
617	76.3
618	101.6

단위 (m/m)

스텐속 마구리



NO.	Size
	외경(A×B)
611-1	19.1
612-1	25.4
613-1	31.8
614-1	38.1
615-1	50.8
616-1	63.5
617-1	76.3
618-1	101.6

단위 (m/m)

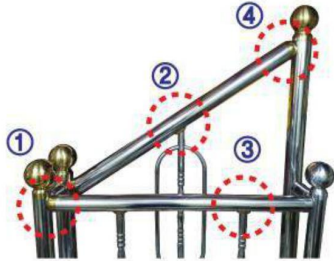

파이프 각도기(90°)

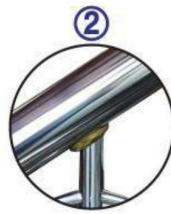

상캡(45°)



상캡(90°)



파이프 각도기(45°)

파이프 각도기 (90°) ※ 본사 특허등록 제품 ※

단위 (m/m)

NO.	Size	
	∅	각도
628	25.4	90°
629	31.8	90°
630	38.1	90°
631	50.8	90°
632	63.5	90°
633	76.3	90°
634	101.6	90°

파이프 각도기 (45°) ※ 본사 특허등록 제품 ※

단위 (m/m)

NO.	Size	
	∅	각도
635	25.4	45°
636	31.8	45°
637	38.1	45°
638	50.8	45°
639	63.5	45°
640	76.3	45°
641	101.6	45°

상캡 (용접용) 90°

단위 (m/m)

NO.	Size		비고
	∅	각도	
642	19	90°R	(50∅용, 63∅용)
643	25.4	38용 90°R	
644		50용 90°R	
645	63용 90°R		
646	32	90°R	
647	38	90°R	

상캡 (용접용) 45°

단위 (m/m)

NO.	Size		비고
	∅	각도	
648	19	45°R	(50∅용, 63∅용)
649	25.4	38용 45°R	
650		50용 45°R	
651	63용 45°R		
652	32	45°R	
653	38	45°R	

비용접용 90°(발)

단위 (m/m)

NO.	Size	
	∅	외경(B)
654	19	90°(발)
655	25	90°(발)
656	32	90°(발)
657	38	90°(발)

비용접용 45°(발)

단위 (m/m)

NO.	Size	
	∅	외경(B)
658	19	45°(발)
659	25	45°(발)
660	32	45°(발)
661	38	45°(발)

25∅비용접 - 고무 (90°/45°)



90°(고무)

45°(고무)

25∅평상캡 - 각파이프용 (90°/45°)



90°(평)

45°(평)

난간동자 - 25.4∅

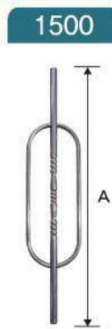

단위 (m/m)

NO.	Size		NO.	Size	
	A	강종		A	강종
1500	500	201	1506	500	304
1501	600	201	1507	600	304
1502	700	201	1508	700	304
1503	800	201	1509	800	304
1504	900	201	1510	900	304
1505	1000	201	1511	1000	304



신주 공



단위 (m/m)

NO.	Size	NO.	Size
	Ø		Ø
666	35	674	110
667	40	675	125
668	53	676	150
669	60	677	200
670	75	678	250
671	90	679	300
672	95	680	500
673	100	681	400

장식볼탑



단위 (m/m)

NO.	Size	
	Ø ₁	Ø ₂
726	50.8	60.8
727	63.5	73.5
728	76.3	86.3

스텐 공

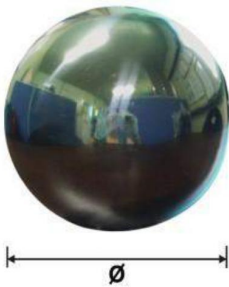

단위 (m/m)

NO.	Size	NO.	Size
	Ø		Ø
682	35	691	125
683	40	692	150
684	53	693	200
685	60	694	250
686	75	695	300
687	90	695-1	330
688	95	695-2	400
689	100	696	500
690	110	1450	1000

스텐 반공

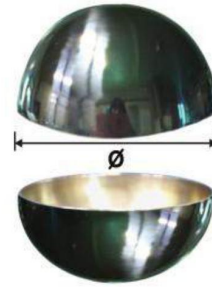

단위 (m/m)

NO.	Size	NO.	Size
	Ø		Ø
1400	30	1400	100
1401	35	1401	110
1402	40	1402	125
1403	50	1403	150
1404	53	1404	200
1405	60	1405	210
1406	70	1406	250
1407	75	1407	300
1408	90	1408	400
1409	95	1409	500

공 + 쪼인트 부착(볼탑)일체형

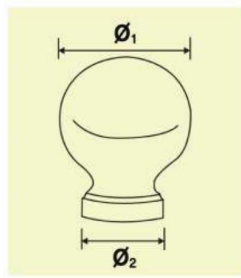

단위 (m/m)

NO.	Size		NO.	Size	
	Ø ₁	Ø ₂		Ø ₁	Ø ₂
697	53	25.4	705	95	63.5
698	60	31.8	706	110	63.5
699	60	38.1	707	110	76.3
700	75	38.1	708	125	63.5
701	75	50.8	709	125	76.3
702		50.8(201)	710	125	101.6
703		63.5(201)	711	200	127.0
704	90	50.8	712	200	152.4

볼탑 (반달공)

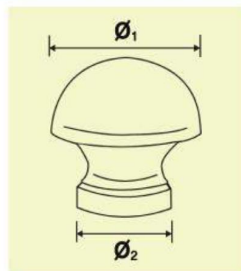

단위 (m/m)

NO.	Size		NO.	Size	
	Ø ₁	Ø ₂		Ø ₁	Ø ₂
713	75	38.1	719	125	63.5
714	75	50.8	720	125	76.3
715	90	50.8	721	150	101.6
716	95	63.5	722	200	152.4
717	110	63.5			
718	110	76.3			



한쪽관통



단위 (m/m)

NO.	Size		비고
	내경∅	외경∅	
730	38.1	95	
731	50.8	95	
732	63.5	95	

양쪽관통

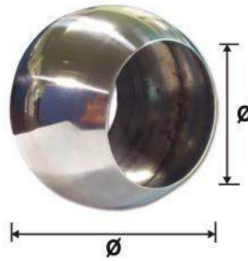

단위 (m/m)

NO.	Size		비고
	내경∅	외경∅	
733	50.8	61	
734	38.1	95	
735	50.8	95	
736	63.5	95	45°관통
			90°관통
			T형관통
			50.8∅
			63.5∅

스텐 장식봉(포인트 부착)



단위 (m/m)

NO.	Size		비고
	∅	∅'	
738	80	50.8	장식봉小
739	100	63.5	장식봉中
741	150	101.6	장식봉特大

자바라 볼탑



단위 (m/m)

NO.	Size	
	∅	∅'
742	53	38.1
742-1	로라카바	
	(T0.9, T1.0 시공가능)	

로라카바



볼 포인트



단위 (m/m)

NO.	Size
	∅
743	25.4
744	31.8
745	38.1
746	50.8
747	63.5
748	76.3
749	89.1
750	101.6
751	127
752	152.4

스텐 소켓트



단위 (m/m)

NO.	Size		
	내경∅(A)	외경∅(B)	높이(H)
753	25.4	56	20
754	31.8	65	23
755	38.1	77	20

25∅ 원형소켓트



크롬

25∅ U소켓트



크롬

놀이터 캡 (목재용 볼트 와사)



홀 13∅
외경 47∅



홀 15.3∅
외경 57∅



스텐단구

※ 길이 조정 가능합니다 ※



단위 (m/m)

NO.	Size	
	Ø	목높이
760	15.8	21
761	19.1	21
762	25.4	20
763	31.8	20
764	38.1	30
765	50.8	35
766	63.5	35

스텐양구

※ 길이 조정 가능합니다 ※



단위 (m/m)

NO.	Size	
	Ø	목높이
767	15.8	21
768	19.1	21
769	25.4	20
770	31.8	20
771	38.1	30
772	50.8	35
773	63.5	35

스텐 후렌지

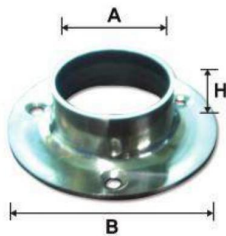

단위 (m/m)

NO.	Size		
	내경Ø(A)	외경Ø(B)	높이(H)
774	25.4	50	14
775	31.8	59	14
776	38.1	65	16
777	50.8	76	20
778	63.5	93	23
779	76.3	110	23
780	101.6	139	27

신주 후렌지

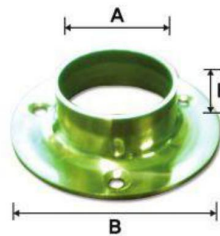

단위 (m/m)

NO.	Size		
	내경Ø(A)	외경Ø(B)	높이(H)
781	25.4	50	14
782	31.8	59	14
783	38.1	65	16
784	50.8	76	20
785	63.5	93	23
786	76.3	110	23
787	101.6	139	27

스텐 후렌지 캡



단위 (m/m)

NO.	Size		
	내경Ø(A)	외경Ø(B)	높이(H)
788	25.4	58	18
789	31.8	66	20
790	38.1	71	22
791	50.8	84	23
792	63.5	101	26
793	76.3	115	29
794	101.6	148	32

가로등 캡



단위 (m/m)

NO.	Size		
	내경Ø(A)	외경Ø(B)	높이(H)
795	101.6	250	100
796	152.4	320	180
797	170	365	205
798	220	425	220
799	76.3	250	100
780	127	250	100

※ 분리형 제작 및 주문제작 가능합니다 ※

파이프 홀더



단위 (m/m)

NO.	Size	
	Ø	목높이
801	25.4	12Ø홀더에 적용
802	31.8	12Ø홀더에 적용
803	38.1	12Ø홀더에 적용
804	50.8	12Ø홀더에 적용

안전봉 고리

※ 본사 특허등록 제품 ※

805

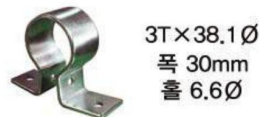

3T×38.1Ø
폭 30mm
홀 6.6Ø

806



3T×50.8Ø
폭 30mm
홀 9.9Ø

805-1



2T×38.1Ø
폭 20mm
홀 5Ø

806-1



2T×50.8Ø
폭 20mm
홀 5Ø



경보스텐산업
KYUNG-BO STAINLESS IND.

Shopping mall 스텐세일
www.stainsale.com

스텐 와샤 (T1.0)

※ 본사 특허등록 제품 ※

807	808	809	810	811	812	813
101.6Ø	76.3Ø	63.5Ø	50.8Ø	38.1Ø	31.8Ø	25.4Ø (내경 : 6Ø, 8Ø, 12Ø)

스텐 평와샤 (R형) (T3.0)

814	815	816	817	818	819	820
101.6Ø 외경 110Ø	76.3Ø 외경 82Ø	63.5Ø 외경 72Ø	50.8Ø 외경 56Ø	38.1Ø 외경 42Ø	31.8Ø 외경 42Ø	25.4Ø 외경 30Ø

스텐 평와샤 (T3.0) 홀 12Ø

821	822	823	824	825	826	827
101.6Ø 외경 110Ø	76.3Ø 외경 82Ø	63.5Ø 외경 72Ø	50.8Ø 외경 56Ø	38.1Ø 외경 42Ø	31.8Ø 외경 42Ø	25.4Ø 외경 30Ø

포스트바(캡, 밀판)

833
80mm X 80mm
포스트 사각바
전장 1,000mm



스텐 평 와샤 (T2.0)

830	831	832
38.1Ø 외경 42Ø	31.8Ø 외경 42Ø	25.4Ø 외경 30Ø
829-2	829-1	829
76.3Ø 외경 82Ø	63.5Ø 외경 72Ø	50.8Ø 외경 56Ø

태극기

※ 본사 특허등록 제품 ※

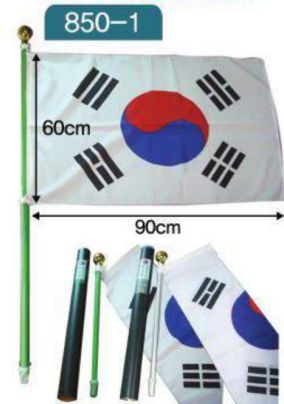

바람에 영키지않는 태극기
(케이스 포함)
깃대종류 - 알루미늄 / 플라스틱



스텐 국기봉



단위 (m/m)

NO.	Size	비고
	Ø	
840	60	특小
841	80	小
842	100	中
843	130	大
844	150	특大

황금(스텐-티타늄 도금/신주)국기봉



단위 (m/m)

NO.	Size	비고	파이프 치수
	Ø		
845	60	특小	25/32
846	80	小	32/38
847	100	中	38/50
848	130	大	50/63
849	150	특大	63/76

국기대받침

850



높이 340mm

국기꽃이

851

※ 본사 특허등록 제품 ※



국기꽃이 신형

852

※ 본사 특허등록 제품 ※



국기꽃이 벽부

853

※ 본사 특허등록 제품 ※



로프걸이

854



이중 로프걸이

855



국기로라

856



곡와샤

857



국기봉 롱볼트 (16Ø)

858

小 50.8Ø / 63.5Ø겸용
230mm

859

中 76.3Ø
270mm

860

大 101.6Ø
340mm

861

특大 127Ø
420mm

레듀샤



단위 (m/m)

NO.	Size		NO.	Size	
	Ø ₁	Ø ₂		Ø ₁	Ø ₂
862	25.4	31.8	871	63.5	101.6
863	25.4	38.1	872	76.3	89.1
864	31.8	38.1	873	76.3	101.6
865	31.8	50.8	874	76.3	127.0
866	38.1	50.8	875	89.1	101.6
867	38.1	63.5	876	101.6	127.0
868	50.8	63.5	877	101.6	152.4
869	50.8	76.3	878	127.0	152.4
870	63.5	76.3	878-1	152.4	216



물훅통 (200mm × 200mm)

※ 비규격 제작 가능합니다 ※

879 상부	880 벽부	881 뚜껑	882 상부	883 벽부	884 뚜껑
76.3Ø	76.3Ø	76.3Ø	101.6Ø	101.6Ø	101.6Ø

물훅통 (250mm × 250mm)

※ 비규격 제작 가능합니다 ※

885 상부	886 벽부	887 뚜껑	888 상부	889 벽부	890 뚜껑
101.6Ø	101.6Ø	101.6Ø	127.0Ø	127.0Ø	127.0Ø

물훅통 반도 (앙카용)

물훅통 반도 (패널용)



단위 (m/m)

NO.	Size			비고
	Ø	발	볼트	
891	50.8	50	48	
892	63.5	50	48	
893	76.3	50	48	
894	101.6	37	48	
895	127.0	50	48	
896	152.4	37	48	
897	60	40	48	PVC용
898	89	40	48	PVC용
899	114	37	48	PVC용
900	216	37	48	



단위 (m/m)

NO.	Size			비고
	Ø	발	볼트	
901	50.8	50	48	
902	63.5	50	48	
903	76.3	50	48	
904	101.6	37	48	
905	127.0	50	48	
906	152.4	37	48	
907	60	40	48	PVC용
908	89	40	48	PVC용
909	114	37	48	PVC용
909-1	165	37	48	
910	216	37	48	

물훅통 파이프 연결링



단위 (m/m)

NO.	Size
	Ø
911	50.8
912	63.5
913	76.3
914	101.6
915	127.0
916	152.4
917	216

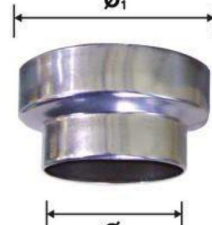

단위 (m/m)

NO.	Size	
	Ø ₁	Ø ₂
918	101.6	50.8
919	101.6	63.5
920	101.6	76.3
921	127.0	101.6
922	152.4	127.0



물훤통(동) (200mm × 200mm)

923 상부
924 벽부



100Ø



100Ø

925 벽부뚜껑



100Ø

물훤통(동) (250mm × 250mm)

926 상부
927 벽부
928 벽부뚜껑



100Ø



100Ø



100Ø

물훤통 연결링(동)

929 930 931 932 933



66.7Ø



79.4Ø



104.8Ø



66.7Ø ~ 104.8Ø



79.4Ø ~ 104.8Ø

물훤통(동)반도



NO.	Size Ø
934	66.7
935	79.4
936	104.8
937	155.6

물받이 구찌



913-1 76Ø용

914-1 101Ø용

915-1 127Ø용

916-1 152Ø용

917-1 216Ø용



914-2 101Ø용

916-2 152Ø용

916-2 152Ø용

916-2 152Ø용

916-2 152Ø용

916-2 152Ø용

916-2 152Ø용

916-2 152Ø용

916-2 152Ø용

916-2 152Ø용

916-2 152Ø용

916-2 152Ø용

916-2 152Ø용

916-2 152Ø용

916-2 152Ø용

916-2 152Ø용

916-2 152Ø용

916-2 152Ø용

916-2 152Ø용

916-2 152Ø용

916-2 152Ø용

물훤통망

938 76.3Ø

939 101.6Ø

940 127.0Ø

스텐고리(파라펫링, 청소용고리)

※ 국내유일 #304 POSCO 원자재 시험성적서 첨부가능 ※

RING 외경 140Ø



280mm X 60mm X T12
250mm X 60mm X T12
링 19Ø

I형 - (비규격 제작도 가능합니다)



상 105mm X 60mm X T12
하 150mm X 74mm X T12
링 19Ø



상 105mm X 60mm X T12
하 150mm X 150mm X T8
링 19Ø



스텐 점검구

※ 비규격 제작 가능합니다 ※

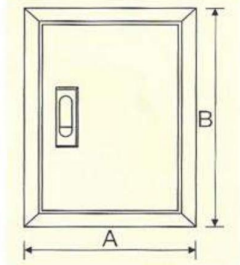

NO.	Size
	A(가로)×B(세로)
945	200×200
946	200×300
947	300×300
948	300×400
949	400×400
950	400×500
951	400×600

단위 (m/m)

NO.	Size
	A(가로)×B(세로)
952	500×500
953	500×600
954	600×600
955	600×700
956	600×800

철 점검구 (갈바)

※ 비규격 제작 가능합니다 ※

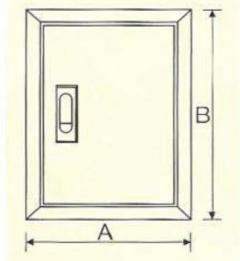

NO.	Size
	A(가로)×B(세로)
957	200×200
958	200×300
959	300×300
960	300×400
961	400×400
962	400×500
963	400×600

단위 (m/m)

NO.	Size
	A(가로)×B(세로)
964	500×500
965	500×600
966	600×600
967	600×700
968	600×800

천정용 점검구 (동전키 타입 / 갈바)

※ 비규격 제작 가능합니다 ※

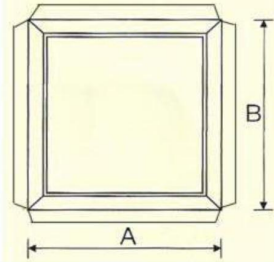

NO.	Size
	A(가로)×B(세로)
957-1	200×200
958-1	200×300
959-1	300×300
960-1	300×400
961-1	400×400
962-1	400×500
963-1	400×600

단위 (m/m)

NO.	Size
	A(가로)×B(세로)
964-1	500×500
965-1	500×600
966-1	600×600
967-1	600×700
968-1	600×800

천정용 점검구 (없는 타입 / 갈바)

※ 비규격 제작 가능합니다 ※

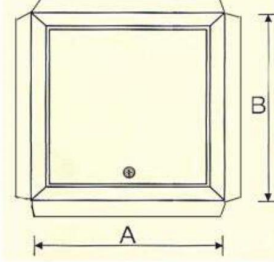

NO.	Size
	A(가로)×B(세로)
957-2	200×200
958-2	200×300
959-2	300×300
960-2	300×400
961-2	400×400
962-2	400×500
963-2	400×600

단위 (m/m)

NO.	Size
	A(가로)×B(세로)
964-2	500×500
965-2	500×600
966-2	600×600
967-2	600×700
968-2	600×800



장애인용 화장실 보조손잡이

※ 31.8Ø가 기본규격이며 주문제작 가능합니다 ※

손잡이(세면대용)

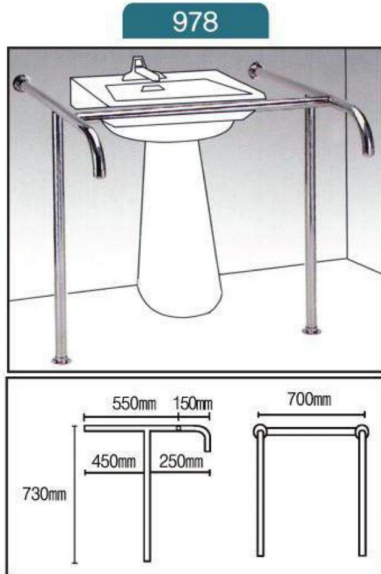

손잡이(소변기용)

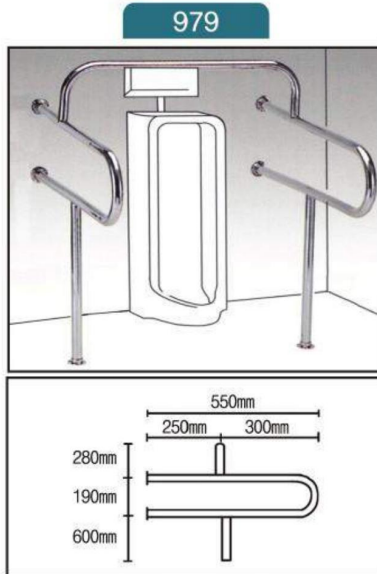

세면대용(세면대용)

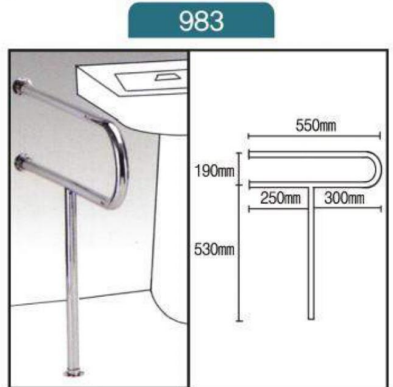
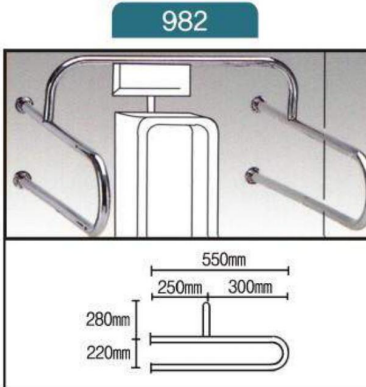
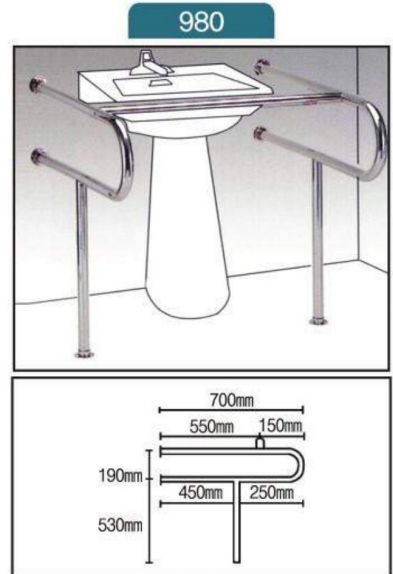

좌변기(좌,우회전용 및 고정)손잡이

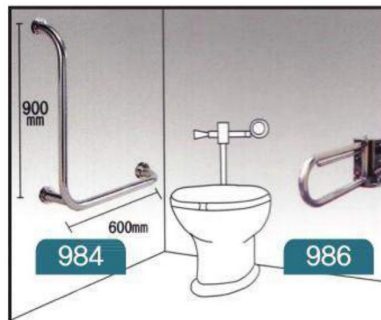

좌변기(상,하전용 및 고정)손잡이

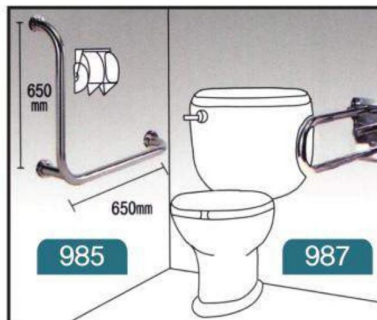

좌변기



※ 각제품 기본규격이며 파이프 밴딩R, 길이, 폭 등 원하시는 규격 제작하여 드리오니 원하시는 도면으로 주문바랍니다. (FAX 또는 직접방문)



장애자 보조 손잡이

※ 비규격 사이즈 제작 가능합니다 ※



NO.	Size	
	굵기(Ø)	센타
1000	25.4	200mm
1001	25.4	250mm
1001-1	25.4	300mm
1002	25.4	350mm
1002-2	25.4	400mm
1003	25.4	450mm
1003-3	25.4	500mm

NO.	Size	
	굵기(Ø)	센타
1004	31.8	250mm
1005	31.8	300mm
1006	31.8	350mm
1007	31.8	400mm
1008	31.8	450mm
1009	31.8	500mm
1010	31.8	550mm
1011	31.8	600mm

우편함

※ 주공용 제작 가능합니다 ※



(올스텐小)

250mm X 160mm X 120mm



(올스텐大)

300mm X 240mm X 120mm

스텐 차단대 (50.8Ø)

신주 차단대 (50.8Ø)

매립 이동식 지차대(분리형)

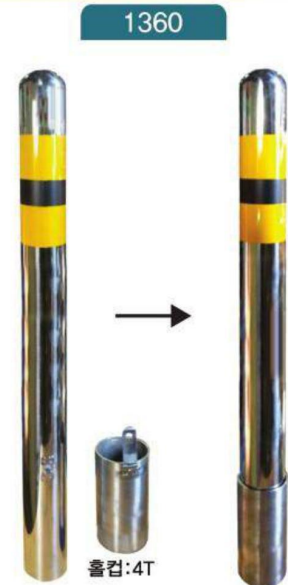

※ 기본 규격은 기둥 1,000mm이며 기둥, 줄은 기본 규격외에도 제작 가능하며 단가는 변동이 있습니다.

※ 기둥 2개 줄 1개가 기본 1조이며 주문제작입니다. (50.8Ø가 기본규격)

※ 사이즈 주문제작 가능합니다 ※



지차대 (매립형)

높이 - 1000mm 높이 변동가능합니다. 체인은 별도입니다. (베이스판 4T)

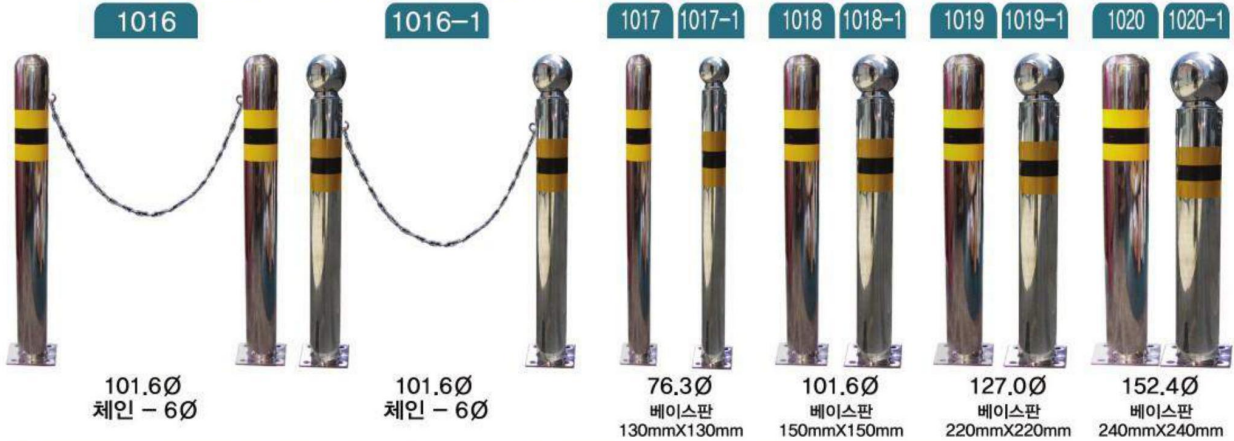

지차대 (매립형)

※ 베이스판 無 ※

높이 - 1300mm 높이 변동가능합니다.

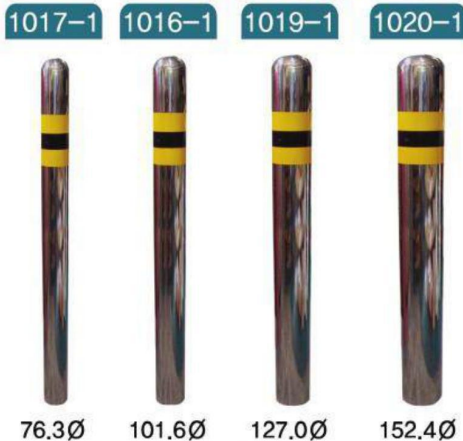

U자 지차대 / U자 볼라드(매립형)

※ 베이스판 無 ※

기본높이 - 600mm 사이즈 변동가능합니다.



베이스판 추가 / 사이즈 (굵기, 가로, 높이) 변동 가능합니다.

지차대 (이동식)

※ 스텐체인은 길이 조절이 가능합니다 ※

높이 - 1000mm 높이 변동가능합니다. 체인은 별도입니다.

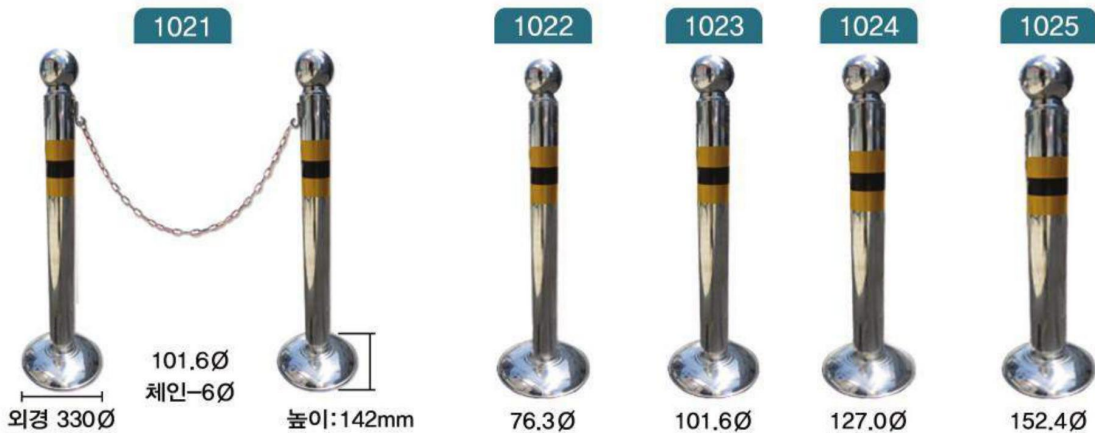



경보스텐산업
KYUNG-BO STAINLESS IND.

Shopping mall 스텐세일
www.stainsale.com

스텐 마르보 빗장 (스텐환봉) - 12.7Ø

250



12.7Ø(마르봉)
300mm(1자)

251



12.7Ø(마르봉)
450mm(1 1/2자)

파이프 통빗장(외부스텐/내부철환봉) - 12.7Ø

252



12.7Ø(칠마르봉)
300mm(1자)

253



12.7Ø(칠마르봉)
450mm(1 1/2자)

파이프 통빗장 (외부스텐 / 내부철환봉) - 15.8Ø

254



15.8Ø(칠마르봉)
300mm(1자)

255



15.8Ø(칠마르봉)
450mm(1 1/2자)

256



15.8Ø(칠마르봉)
600mm(2자)

257



15.8Ø(칠마르봉)
750mm(2 1/2자)

파이프 통빗장 (외부스텐 / 내부철환봉) - 19.1Ø

258



19.1Ø
300mm(1자)

259



19.1Ø
450mm(1 1/2자)

260



19.1Ø
600mm(2자)

261



19.1Ø
750mm(2 1/2자)

파이프 빗장 (내부 비어있음) - 19.1Ø

262



19.1Ø
300mm(1자)

263



19.1Ø
450mm(1 1/2자)

264



19.1Ø
600mm(2자)

265



19.1Ø
750mm(2 1/2자)

파이프 빗장 (내부 비어있음) - 25.4Ø

266



25.4Ø
600mm(2자)

267



25.4Ø
750mm(2 1/2자)

268



25.4Ø
900mm(3자)

스텐 오도시

269



오도시 3인치

269-1



오도시 4인치

270



오도시 5인치

271



스프링 오도시 7인치

272



오도시 10인치



스텐틀짜귀

273	274	275	276	277	278	279	280	281
좌측	우측	겸용	좌측	우측	겸용	좌측	우측	겸용
용접 3 inch×(2T)			용접 4 inch×(3T)			용접 5 inch×(4T)		
282	283	284	285	286	287	288	289	290
좌측	우측	겸용	좌측	우측	겸용	좌측	우측	겸용
(피스)조립식 3 inch×(2T)			(피스)조립식 4 inch×(3T)			(피스)조립식 5 inch×(4T)		

스텐정첩(조립)

290-1		1 1/2 inch
290-2		2 inch
290-3		2 1/2 inch
290-4		3 inch
290-5		4 inch

16Ø샷다 링

센타 80mm			센타 85mm		
291	292	293	294	295	296
16Ø 샷다링	16Ø 상링	16Ø 하링	16Ø 샷다링	16Ø 상링	16Ø 하링

19Ø샷다 링

센타 90mm		
297	298	299
19Ø 샷다링	19Ø 상링	19Ø 하링

스텐정첩(용접)

290-6		1 1/2 inch
290-7		2 inch
290-8		2 1/2 inch
290-9		3 inch
290-10		4 inch

이중 링구 (W링)

300	301	302	303
13Ø이중링구 센타 80mm	16Ø이중링구 센타 80mm	16Ø이중링구 센타 85mm	19Ø이중링구 센타 90mm

스텐샷다 마개

309	310
16Ø 스텐마개	19Ø 스텐마개

샷다고리

305	306	307	308
회전고리 (2.0T)	샷다고리 (2.0T)	키고리소 (2.0T)	키고리대 (2.0T)

대문 힌지

304	
-----	--



각엘보 (조립식 엘보, 환관 엘보)

일자엘보 大



312

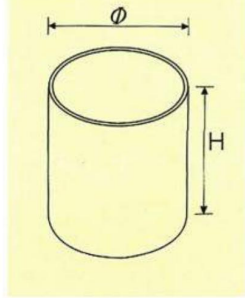

일자조립엘보



※본사 특허등록 제품※

NO.	Size		NO.
	ø	H	
312	152.4	200	
313	127.0	150	
314	101.6	90	314-1
315	76.3	70	315-1
316	63.5	50	316-1
317	50.8	40	317-1
318	38.1	35	318-1
319	31.8	30	
320	25.4	25	
321	19.1	20	

T형 엘보



322

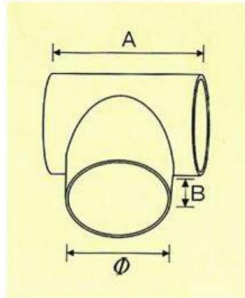

NO.	Size		
	ø	A	B
322	152.4	230	87
323	127.0	180	65
324	101.6	140	50
325	76.3	101	37
326	63.5	95	35
327	50.8	85	32
328	38.1	70	25
329	31.8	65	23
330	25.4	50	22
331	19.1	44	19

ㄱ형 엘보 (90°)



332

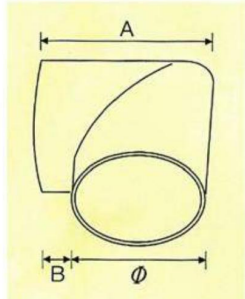

NO.	Size		
	ø	A	B
332	152.4	213	50
333	127.0	188	60
334	101.6	135	34
335	76.3	100	23
336	63.5	90	25
337	50.8	76	20
338	38.1	60	20
339	31.8	51	15
340	25.4	45	15
341	19.1	40	17

45°, 135° ㄱ형 엘보



342

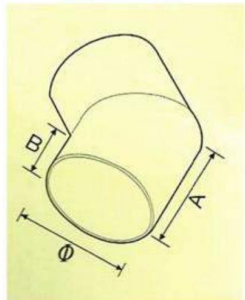

NO.	Size		
	ø	A	B
342	152.4	154	85
343	127.0	107	55
344	101.6	95	50
345	76.3	70	35
346	63.5	60	30
347	50.8	51	30
348	38.1	40	20
349	31.8	34	20
350	25.4	30	19
351	19.1	26	16



다방향 각엘보 (3방향, 십자형, 4방향, 5방향)

3방향 환관엘보(LB)

352

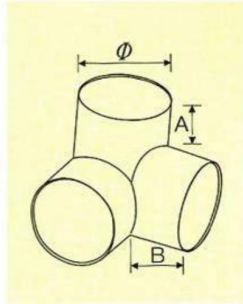

NO.	Size		
	φ	A	B
352	19.1	20	17
353	25.4	17	17
354	31.8	20	20
355	38.1	20	20
356	50.8	27	27
357	63.5	28	28
358	76.3	21	21
359	101.6	47	47

단위 (m/m)

십자형 환관엘보(LB)

360

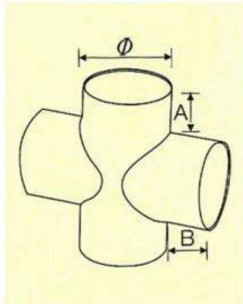

NO.	Size		
	φ	A	B
360	19.1	20	20
361	25.4	22	18
362	31.8	25	22
363	38.1	27	22
364	50.8	31	25
365	63.5	36	29
366	76.3	42	22
367	101.6	57	40

단위 (m/m)

4방향 환관엘보(LB)

368

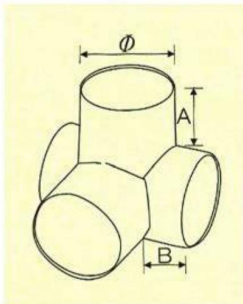

NO.	Size		
	φ	A	B
368	19.1	19	11
369	25.4	22	11
370	31.8	25	11
371	38.1	28	11
372	50.8	31	16
373	63.5	35	16
374	76.3	42	16
375	101.6	60	25

단위 (m/m)

5방향 환관엘보(LB)

376

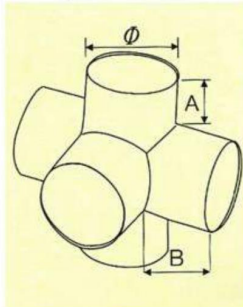

NO.	Size		
	φ	A	B
376	19.1	20	20
377	25.4	22	18
378	31.8	25	22
379	38.1	27	22
380	50.8	31	25
381	63.5	36	29
382	76.3	42	22
383	101.6	57	40

단위 (m/m)



스텐엘보

반쪽 용접엘보 (45°)

384

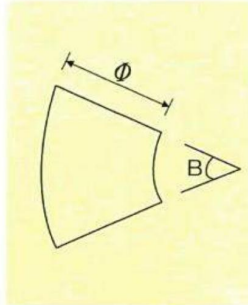
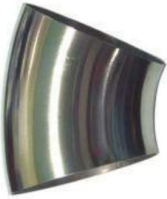

NO.	Size	각도 (B)	NO.	Size	각도 (B)
	ø			ø	
384	25.4	45°	391	127.0	45°
385	31.8	45°	392	152.4	45°
386	38.1	45°	392-1	165	45°
387	50.8	45°	393	216.1	45°
388	63.5	45°			
389	76.3	45°			
390	101.6	45°			

스텐 용접엘보 (90°)

394

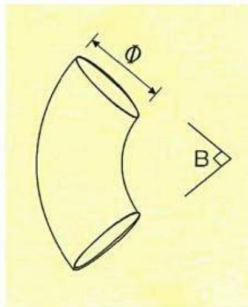

NO.	Size	각도 (B)	NO.	Size	각도 (B)
	ø			ø	
394	15.8	90°	401	76.3	90°
395	19.1	90°	402	89.1	90°
396	25.4	90°	403	101.6	90°
397	31.8	90°	404	127.0	90°
398	38.1	90°	405	152.4	90°
399	50.8	90°	405-1	165	90°
400	63.5	90°	406	216.3	90°

한쪽 엘보 (LB)

407

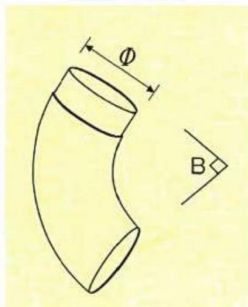

NO.	Size	각도 (B)	NO.	Size	각도 (B)
	ø			ø	
407	19.1	90°	414	101.6	90°
408	25.4	90°	415	127.0	90°
409	31.8	90°	416	152.4	90°
410	38.1	90°			
411	50.8	90°			
412	63.5	90°			
413	76.3	90°			

양쪽 엘보 (LB)

417

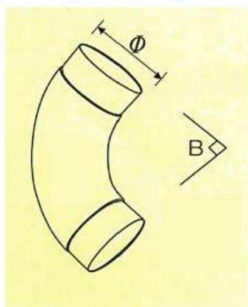

NO.	Size	각도 (B)	NO.	Size	각도 (B)
	ø			ø	
417	19.1	90°	424	101.6	90°
418	25.4	90°	425	127.0	90°
419	31.8	90°	426	152.4	90°
420	38.1	90°			
421	50.8	90°			
422	63.5	90°			
423	76.3	90°			



물훅통 관통 T형 엘보(LB) - 풀용접

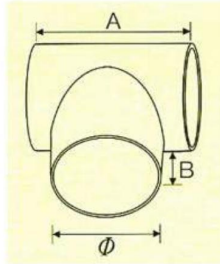
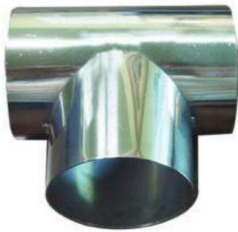

NO.	Size		
	Ø	A	B
427	50.8	104	35
428	63.5	120	43
429	76.3	141	43
430	101.6	175	60
431	127	225	75
432	152	254	85

단위 (m/m)

T형 확산 조립식 엘보(LB)

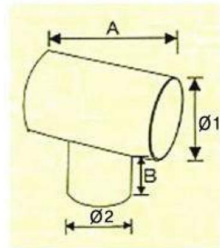

NO.	Size			
	Ø1	Ø2	A	B
433	63.5	50.8	95	40
434	50.8	38.1	85	35
435	38.1	25.4	65	25

단위 (m/m)

벽체(LB)

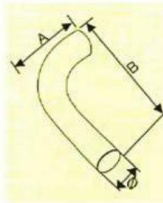

NO.	Size		
	Ø	A	B
438	38.1	120	210
439	31.8	95	180
440	25.4	75	150

단위 (m/m)

한쪽 롱엘보

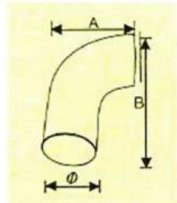

NO.	Size		
	Ø	A	B
444	63.5	110	158
445	50.8	90	138
446	38.1	80	130

단위 (m/m)

* 용도 : 돌출 발코니에 사용하여 한쪽 기준 엘보 길이보다 50cm길게 제작되었습니다.

45° 확산엘보 · 조립엘보



NO.	Size		강종
	Ø	B	
389-1	76.3	45°	201
389-2	76.3	45°	304
390-1	101.6	45°	201
390-2	101.6	45°	304

단위 (m/m)

90° 확산엘보 · 조립엘보

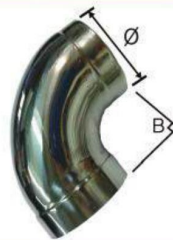

NO.	Size		강종
	Ø	B	
401-1	76.3	90°	201
401-2	76.3	90°	304
403-1	101.6	90°	201
403-2	101.6	90°	304

단위 (m/m)

최신형 풀용접 확산조립엘보 (90°/45°)



NO.	Ø	NO.	Ø	NO.	Ø	NO.	Ø
332-2	216	334-1	101.6	342-2	216	344-1	101.6
332-1	152.4	335-1	76.3	342-1	152.4	345-1	76.3
333-1	127			343-1	127		

한쪽 롱 ㄱ형 확산엘보

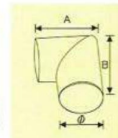

NO.	Size		
	Ø	A	B
436	50.8	75	98
437	38.1	60	92

단위 (m/m)

발코니 엘보(LB)





경보스텐산업
KYUNG-BO STAINLESS IND.

Shopping mall 스텐세일
www.stainsale.com

쪾대함

※ 주문 제작품 (사이즈 변경 가능합니다.) ※

※ 본사 특허등록 제품 ※

※ 본사 특허등록 제품 ※

쪾대함 2단

쪾대함 3단



쪾대함 2단
(측면)

쪾대함 3단
(측면)



재질 : 스테인레스

쪾대함 상세이미지

쪾대함 사이즈



벌레방지 타공판

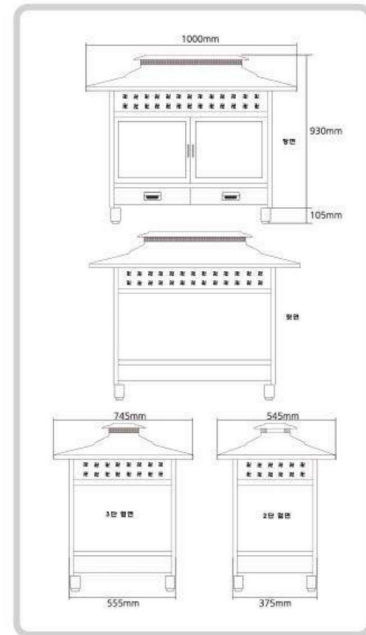



자전거 거치대

※ 주문 제작품 (사이즈 변경 가능합니다.) ※

자전거 거치대 1.6m (4대분)

재질 : 스텐레스



SIZE : 1600mm(W) × 440mm(D) × 600mm(H)

레이저 조각 및 2D · 3D 작업기계



최신 레이저 장비 도입으로 맞춤형 제작, 주문 가능합니다.
SUS레이저 2D · 3D 커팅, 건축스텐부속 제작 가공 전문기업

칼라콘

UV안정제로 탈색 걱정없는
칼라콘



SIZE : L380 × W380 × H680(mm)



설치예시

원형 오투기 표지판

원형으로 제작되어 시인성이 더욱 좋아진
원형 오투기 표지판



SIZE : L340 × W1,090(mm) / 원형판 Ø380



설치예시



강화도어 손잡이

※ 비규격 사이즈도 가능합니다 ※

단위 (m/m)

87	89	90	92	93	95	98	99	101	102
31.8Ø 700	20X40X340 20X40X600	20X40X340 20X40X600	25X25X600 25X25X900 30X30X600 30X30X900	25X25X600 25X25X900 30X30X600 30X30X900	31.8Ø 400X200 600X340 900X540	31.8Ø 880	31.8Ø 850	20X40X340 20X40X600 20X60X340 20X60X600	31.8Ø 1500X700
104	105	106	108	110	111	112	113	113-1	113-2
38Ø + 25Ø 700 X 340	31.8Ø 700X340 1000X600 1500X1000	31.8Ø 38X1800 38X1100	31.8Ø 1100X340 1100X600 1500X1000	31.8Ø 430	31.8Ø 300	31.8Ø 300	31.8Ø 300	600X340	38Ø 700X340 1000X600

아크릴 핸들(원형)

116	117	118	119	120	121	122	123	124
20T X 200Ø	20T X 200Ø	20T X 200Ø	20T X 200Ø	20T X 200Ø	20T X 200Ø	20T X 110Ø	20T X 110Ø	20T X 110Ø
125	126	127	128	129	130	131	132	133
20T X 110Ø	20T X 110Ø	20T X 110Ø	20T X 75Ø	20T X 75Ø	20T X 75Ø	20T X 75Ø	20T X 75Ø	20T X 75Ø



강화도어 손잡이

※ 비규격 사이즈도 가능합니다 ※

단위 (m/m)

35	36	37	38	39	40	49	50	51	54
31.8Ø 900X (400X400)	31.8Ø 1000	31.8Ø 600X340 800X340	(20X40) 1000	30T 600X340 (사각)	30T 600X340 (사각)	38.1Ø 700X340	38.1Ø 700X340	38.1Ø 700X340	31.8Ø 31.8ØX600
55	56	57	59	60	61	62	63	64	70
25.4ØX 31.8Ø 340	25.4ØX 31.8Ø 340	25.4Ø 200	31.8Ø 700	38.1Ø 600X340 460X200	38.1Ø 600X340 460X200	31.8Ø 700X340	31.8Ø 700X340	38.1Ø 700X340 31.8Ø 700X340	38.1Ø 700X340
71	73	79	80	81	82	83	84	85	86
38.1Ø 700X340	25.4Ø 200X550	35Ø 640X340	38Ø 600X340	38Ø 700X340	(9X50) 600X340	(9X50) 600X340	(9X50) 600X340	(9X50) 600X340	(20X40) 400X200 700X340



강화도어 손잡이

※ 비규격 사이즈도 가능합니다 ※

단위 (m/m)

1	2	3	5	6	7	8	9	10	11
31.8Ø 700X340	31.8Ø 600X340	31.8Ø 600X340	31.8Ø 600X340	31.8Ø 1600	31.8Ø 1700	31.8Ø 1500 (400X400X400)	31.8Ø 1500X700	31.8Ø 1200	31.8Ø 600X340 800X600 1000X800
11-4	12	13	14	15	16	17	18	19	20
 실버 시트지부착									
31.8Ø 600X340	31.8Ø 600X340	31.8Ø 600X340	31.8Ø 600 450	31.8Ø 600 450	31.8Ø 1500 (600X600)	31.8Ø 75X1200	31.8Ø 1300 (센타)	31.8Ø 1200X600	31.8Ø 1200
21	22	24	25	26	27	31	32	33	34
31.8Ø 600 450	38Ø 600X340	(20X40) 600X340	(20X40) 600X340	(20X40) 600X340	(20X40) 600X340	31.8Ø 700	31.8Ø 1000	31.8Ø 1000X600	31.8Ø 1000X600



보조키

239

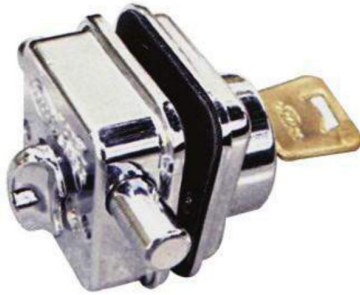

스트라이크

240



유리 구멍마개

241



재질 : 스텐
유리구멍 마개

242



재질 : 신주
유리구멍 마개

유리걸이 (스텐, 신주)

243



스텐 8mm / 12mm
SIZE : 3T X 40mm X 40mm

244



신주 8mm / 12mm
SIZE : 3T X 40mm X 40mm

흠부속

245



12mm
SIZE : 50mm X 50mm

246



12mm
SIZE : 3T X 32mm X 40mm

유리걸이

247



8mm / 12mm
SIZE : 4T X 40mm X 75mm

248



8mm / 12mm
SIZE : 4T X 60mm X 50mm

249



12mm
SIZE : 4T X 60mm X 60mm



가네모 흰지 후렴부속

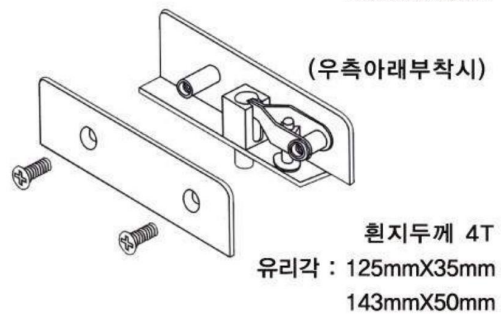
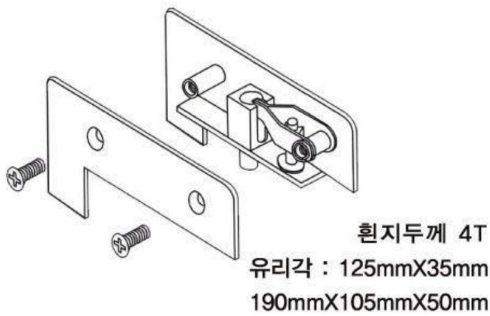
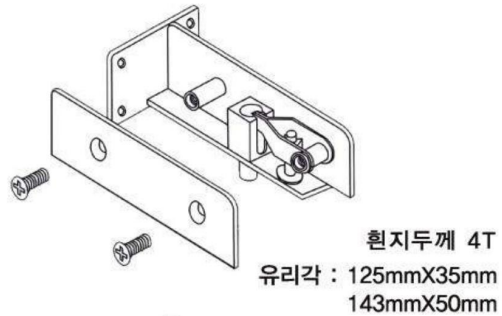

※ 경고 문 ※
본사 특허 등록 제품 및 출원 제품을 모방 및 유통 또는 위변조 할시에는
민사, 형사 처벌을 받을 수 있습니다.
(본 문구는 내용증명을 갈음합니다.)

스텐세일 www.kbsteel.com
www.stainsale.com

www.steelkb.co.kr



 **경보스텐산업**
 KYUNG-BO STAINLESS IND.

 **경보레이저** 기술 금속
 KYUNG-BO LASER TECHNO METAL.

대구광역시 북구 침산로 252
 Tel : 053) 351-7205
 353-7205
 354-7205
 356-7205
 Fax : 053) 358-7205
kbsteelcom@naver.com